

SRM450v2

The Mackie SRM450v2 is a full-range, portable, powered loudspeaker system providing high-output, ultra-wide dispersion and low-distortion performance in a compact, lightweight design. Two Fast Recovery™ amplifiers independently power a 12-inch neodymium woofer and a precision titanium compression driver. Mackie's sophisticated Active electronics provide phase correction, crossover, time correction, equalization and protection circuitry.

A heat-treated titanium compression driver with multi-cell aperture directs pristine highs through an exponential high-frequency waveguide, allowing for ultra-wide dispersion. This allows the SRM450v2 to deliver clear, smooth sound to audience members up to 45° off axis.

The 12-inch neodymium woofer provides a greater magnetic field with far less material, making the woofer extremely lightweight without sacrificing performance. The 3-inch voice coil allows the driver to run cooler, delivering consistent performance even after long hours of use.

Mackie-designed Active electronics provide equalization, crossover, time alignment, and phase correction to enhance sonic performance. Protective circuitry includes over-excursion protection, low-line voltage shut-down, thermal protection, level dependent low-frequency roll-off and independent LF and HF limiters.

The SRM450v2 features a number of dedicated controls including a mic/line switch, a single microphone and line input level control, and a contour switch for low-level sound reinforcement applications. There is also a timed turnoff feature that turns off the amplifiers if the signal drops below -45 dBu for three minutes.

The center of gravity, handle locations, handle design, position of fly-points and ease of use have been ergonomically designed. There is also an integrated pole mount cup and a weather-resistant steel grille. The asymmetrical trapezoidal cabinet has been designed to provide an ideal floor monitoring position.

The cabinet is constructed of high-pressure injected polypropylene. The enclosure features ample amounts of reinforcement ribbing and structural strengthening resulting in a strong, super-rigid design providing ideal acoustical characteristics.

APPLICATIONS

Small to mid-size club/band PA systems, houses of worship, DJs, vocal/band monitor wedges, gymnasiums, banquet halls, conference rooms and many, many more.



FEATURES:

- 2-way bi-amplified, optimized powered loudspeaker system
- 300W RMS Class-D, Fast Recovery™ LF amp / 100W RMS HF amp
- 12" neodymium long-throw low-frequency transducer with 3" voice coil and servo feedback control
- High-output precision titanium compression driver
- Ultra-wide, smooth dispersion via multi-cell horn aperture and HF waveguide
- Mackie Active electronic time alignment, phase correction and EQ for studio quality sound
- Built-in phase-accurate 24 dB Linkwitz-Riley electronic crossover
- Mic/line input and pass-thru connector
- Lightweight for ultimate portability (40 lb / 18.1 kg)
- Asymmetrical trapezoidal cabinet for floor monitor positioning
- Stand / Pole-mountable
- Flyable via ten M10 rigging points using the optional eyebolt kit

SRM450v2 SPECIFICATIONS

Acoustic Performance

Frequency Response (-3 dB)	55 Hz - 18 kHz
Frequency Range (-10 dB)	45 Hz - 20 kHz
Directivity Factor; Q (DI)	9.95 (9.98), averaged 2 kHz to 10 kHz
Max SPL long-term	124 dB @ 1 m
Max SPL peak	127 dB @ 1 m
Crossover Point	Linkwitz-Riley, 24 dB/octave @ 1600 Hz

Input / Output

Input / Thru Type	Balanced Differential
Input Impedance	20 kΩ
Input Protection	RFI and level protected

Sensitivity

Line	+4 dBu (center detent)
Mic	-36 dBu
Maximum Input Level	+22 dBu
Low-Cut Frequency	75 Hz, Second-order filter
Acoustic Contour Equalization (Peaking)	+3 dB @ 100 Hz, +3 dB @ 12 kHz

Low-Frequency Power Amplifier

Rated Power	300 watts rms*
Rated THD	< 0.1%
Cooling	Convection Extrusion
Design	Class D, Parametric Servo Feedback

High-Frequency Power Amplifier

Rated Power	100 watts rms*
Rated THD	< 0.1%
Cooling	Convection Extrusion
Design	Conventional Class AB

*Rated power is continuous rms wattage into transducer's rated impedance @ 5kHz for the HF amplifier and @ 500Hz for the LF amplifier.

Low-Frequency Transducer

Diameter	12 in / 305 mm
Voice Coil Diameter	3 in / 76 mm
Magnet Material	Neodymium

High-Frequency Transducer

Diaphragm Diameter	1.75 in / 44 mm
Diaphragm Material	Heat treated titanium

Horn Design

Type	Conical and Exponential
Mouth Size	12 in / 305 mm (W) x 7 in / 178 mm (H)
Throat Diameter	1 in / 25 mm
Horizontal Coverage	90° (1 kHz - 20 kHz)
Vertical Coverage	45° (2.8 kHz - 20 kHz)

Line Input Power

US, JP	100 - 120 VAC, 50 - 60 Hz
EU, UK, AU, CN	200 - 240 VAC, 50 - 60 Hz
AC Connector	3-pin IEC 250 VAC
Power Consumption	300 watts

Control System Function

Electronic Crossover, Phase Alignment, Equalization, Parametric EQ

Safety Features

Over-Excursion Protection	Second-Order High-Pass Filter
Thermal Protection	Amplifier shutdown, auto-reset
Low-Line Voltage Shut Down	60% Nominal line
Driver Protection	Independent LF and HF compressors
Low-Freq Roll-Off	Dynamic, signal-level dependent

Construction Features

Basic Design	Asymmetrical Trapezoidal
Enclosure Alignment	Sixth-Order
Material	Polypropylene
Finish	Black, textured finish
Handles	One on each side, one on top
Grille	Perforated metal with weather-resistant coating
Display LEDs	Signal Present, Peak, Power ON, and Thermal
Operating Temperature	-10°C - 45°C 14°F - 113°F

Physical Properties (packaged product)

Height	26.5 in / 673 mm
Width	16.8 in / 427 mm
Depth	15.5 in / 394 mm
Shipping Weight	46.0 lb / 20.9 kg

Physical Properties (product)

Height	26.1 in / 663 mm
Width	16.0 in / 406 mm
Depth	14.8 in / 376 mm
Net Weight	40.0 lb / 18.1 kg

Mounting Methods

Floor mount, pole mount, or fly via 10 integrated M10 threaded inserts (two each located on each side, top, bottom and rear of enclosure)

Options

PA-A1 Forged Shoulder Eyebolt Kit	P/N 0031943
SPM200 Loudspeaker Pole Mount	P/N 2035170-01

Ordering Information

SRM450v2 12"2-way Compact SR Loudspeaker, US	P/N 2033799-00
SRM450v2 12"2-way Compact SR Loudspeaker, EU	P/N 2033799-01
SRM450v2 12"2-way Compact SR Loudspeaker, JP	P/N 2033799-02
SRM450v2 12"2-way Compact SR Loudspeaker, UK	P/N 2033799-03
SRM450v2 12"2-way Compact SR Loudspeaker, AU	P/N 2033799-04
SRM450v2 12"2-way Compact SR Loudspeaker, CN	P/N 2033799-05

SRM450v2 HORIZONTAL POLARS

Gridlines: 6 dB axial / 15 degrees radial

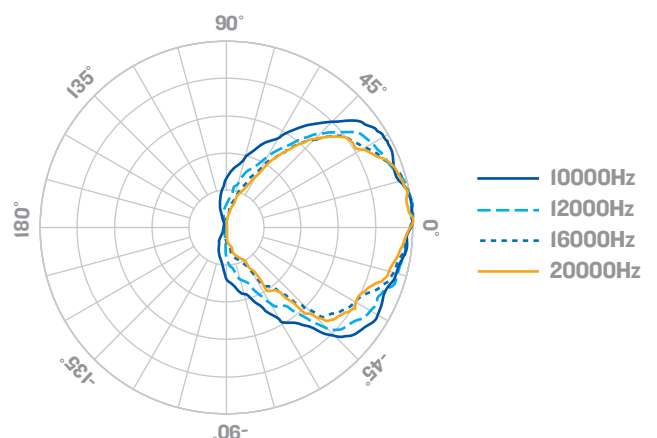
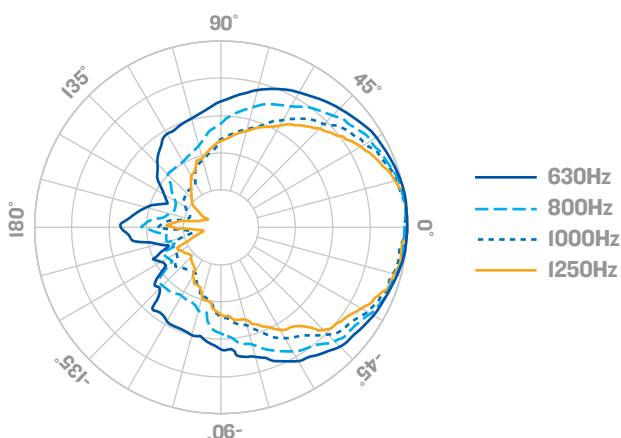
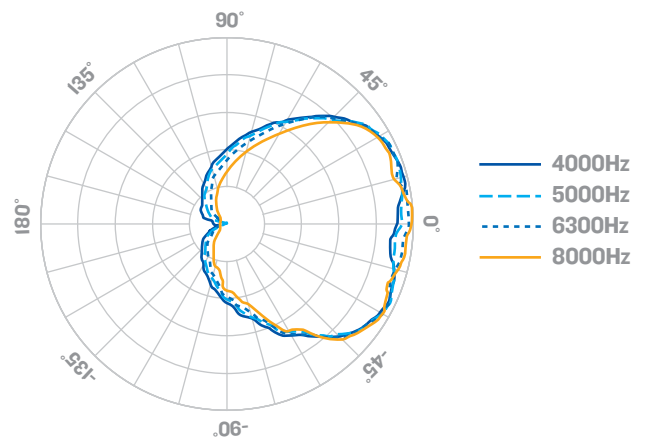
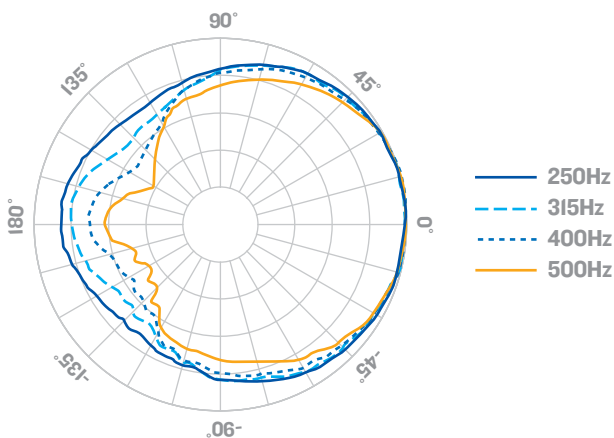
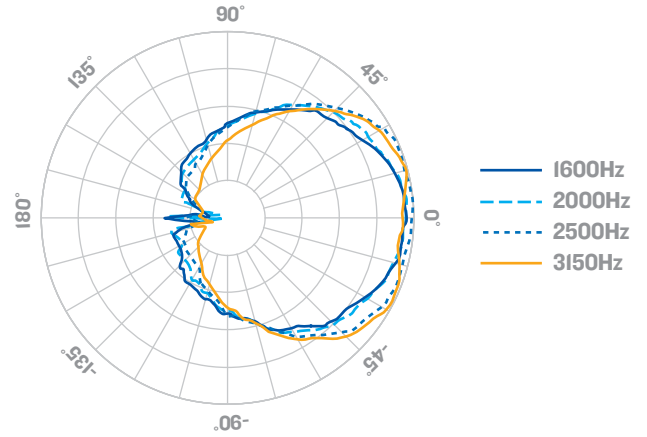
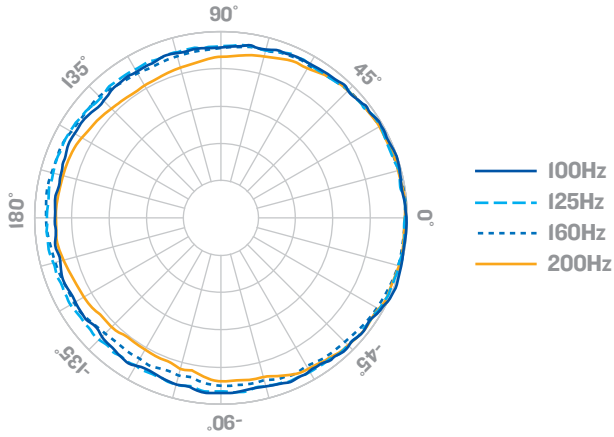

SRM450v2 VERTICAL POLARS

Gridlines: 6 dB axial / 15 degrees radial

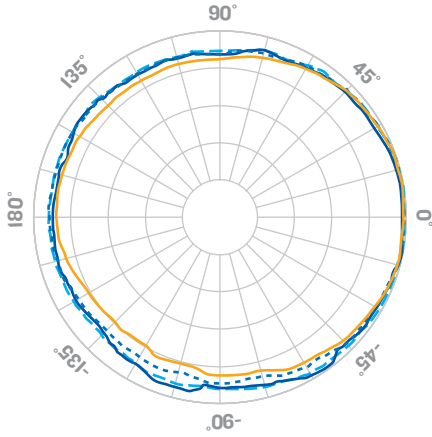

- 100Hz
- - - 125Hz
- ... 160Hz
- 200Hz

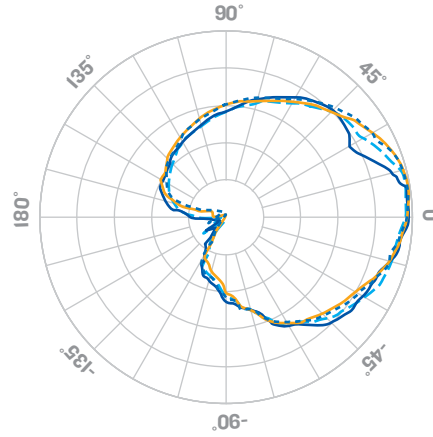

- 1600Hz
- - - 2000Hz
- ... 2500Hz
- 3150Hz

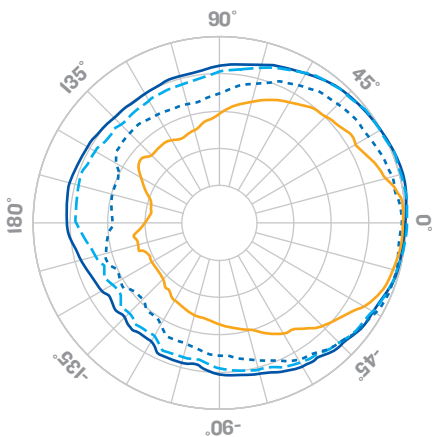

- 250Hz
- - - 315Hz
- ... 400Hz
- 500Hz

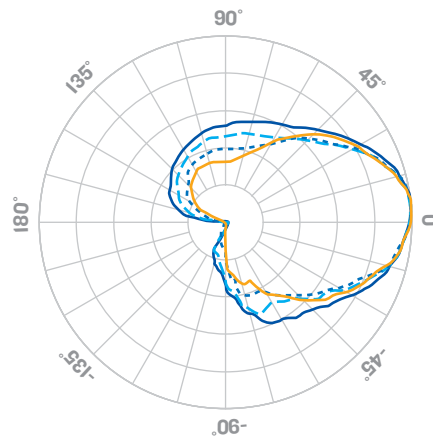

- 4000Hz
- - - 5000Hz
- ... 6300Hz
- 8000Hz

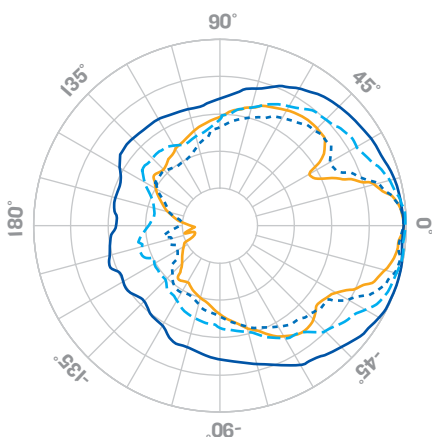

- 630Hz
- - - 800Hz
- ... 1000Hz
- 1250Hz

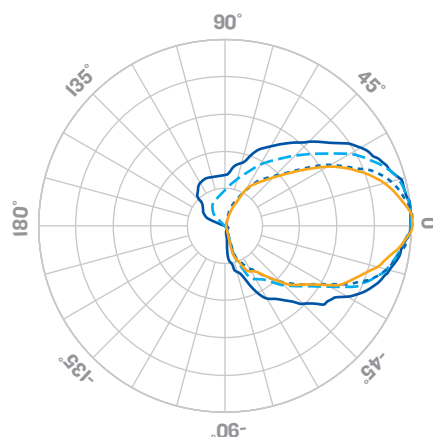

- 10000Hz
- - - 12000Hz
- ... 16000Hz
- 20000Hz

SRM450v2 FREQUENCY RESPONSE

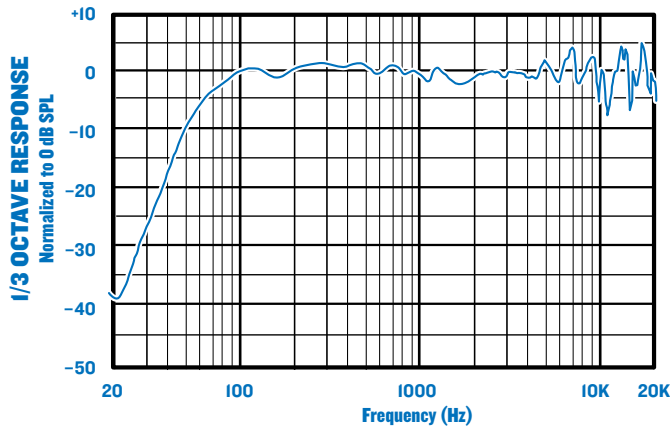

SRM450v2 INPUT PANEL

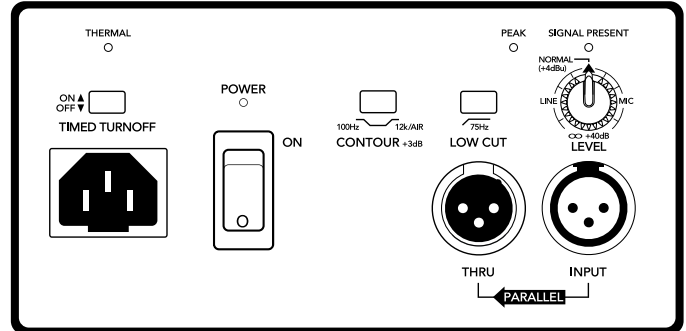

SRM450v2 DIMENSIONS

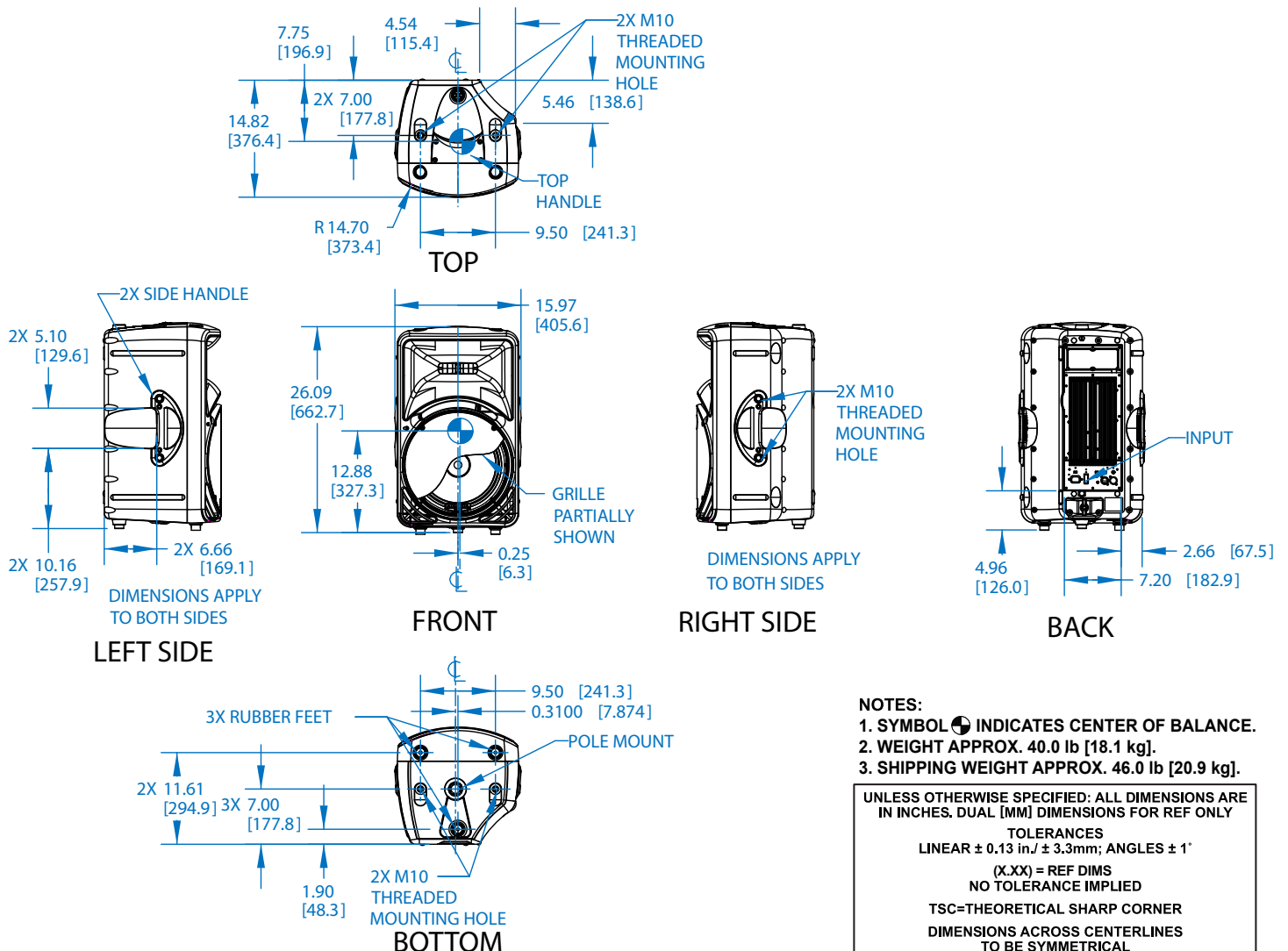

NOTES:

1. SYMBOL INDICATES CENTER OF BALANCE.
2. WEIGHT APPROX. 40.0 lb [18.1 kg].
3. SHIPPING WEIGHT APPROX. 46.0 lb [20.9 kg].

UNLESS OTHERWISE SPECIFIED: ALL DIMENSIONS ARE IN INCHES. DUAL [MM] DIMENSIONS FOR REF ONLY

TOLERANCES
LINEAR ± 0.13 in./ ± 3.3 mm; ANGLES $\pm 1^\circ$

(X.XX) = REF DIMS
NO TOLERANCE IMPLIED

TSC=THEORETICAL SHARP CORNER

DIMENSIONS ACROSS CENTERLINES
TO BE SYMMETRICAL

SRM450v2 BLOCK DIAGRAM

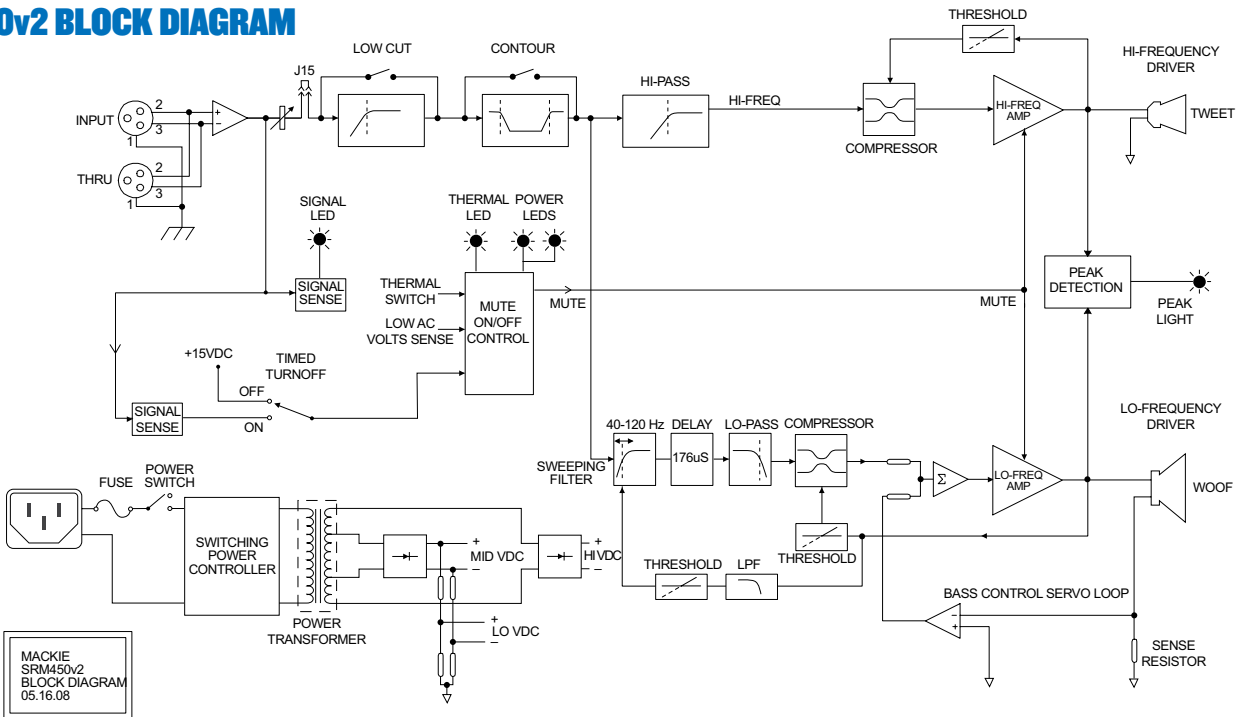

SRM450v2 FLY POINTS

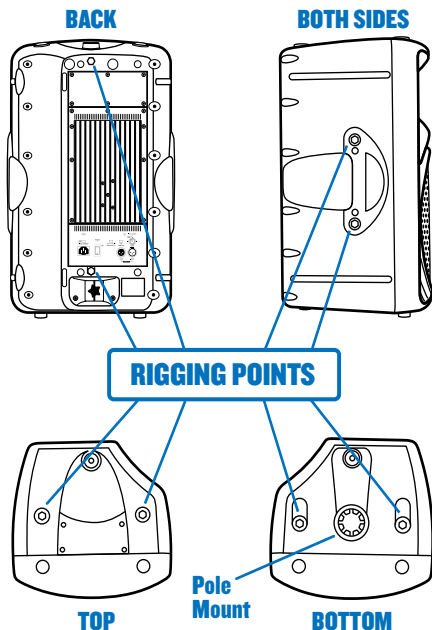

Electronic files for this product are available at:
www.mackie.com

Specification Sheet	SRM450v2_SS.PDF
Owner's Manual	SRM450v2_OM.PDF

Since we are always striving to make our products better by incorporating new and improved materials, components, and manufacturing methods, we reserve the right to change these specifications at any time without notice. "Mackie" and the "Running Man" figure are registered trademarks of LOUD Technologies Inc. All other brand names mentioned are trademarks or registered trademarks of their respective holders, and are hereby acknowledged.

©2010 LOUD Technologies Inc. All Rights Reserved.

MACKIE®

www.mackie.com
 16220 Wood-Red Road NE
 Woodinville, WA 98072 USA
 800-898-3211, Fax 425-487-4337, sales@mackie.com

Part No. SW0841 Rev. A 06/10